

圧力荷重換算表

1000kN75ストローク 油圧ジャッキ H=195mm

最低機械高	195 mm
受圧面積	165.1 cm ²
最高使用圧力	60.6 MPa
所要油量	1.2 L
重量	約35 kg

圧力 : MPa $\times 10.2$ \rightarrow kg/cm²
 荷重 : ton $\times 9.8$ \rightarrow kN
 圧力[MPa] × 受圧面積[cm²] / 10 = 荷重[kN]

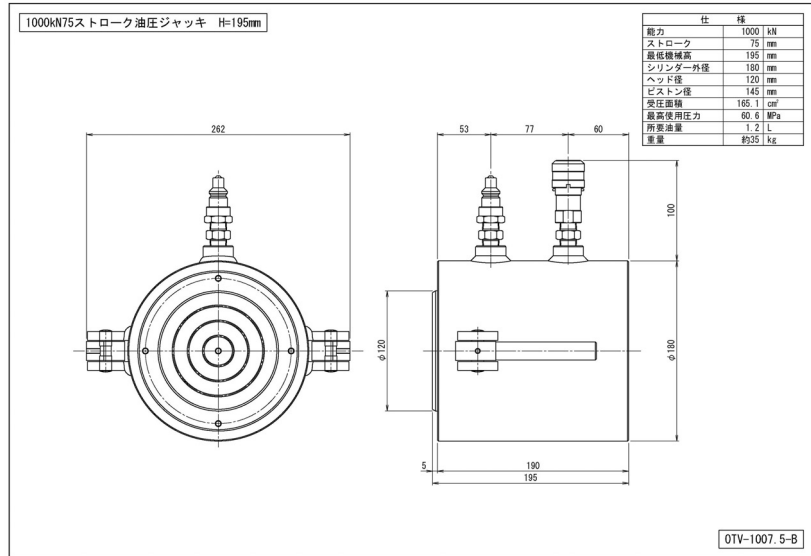

圧力		荷重	
MPa	kg/cm ²	kN	ton
1	10	17	1.7
2	20	33	3.4
3	31	50	5.1
4	41	66	6.7
5	51	83	8.4
6	61	99	10.1
7	71	116	11.8
8	82	132	13.5
9	92	149	15.2
10	102	165	16.8
11	112	182	18.5
12	122	198	20.2
13	133	215	21.9
14	143	231	23.6
15	153	248	25.3
16	163	264	26.9
17	173	281	28.6
18	184	297	30.3
19	194	314	32.0
20	204	330	33.7

圧力		荷重	
MPa	kg/cm ²	kN	ton
21	214	347	35.4
22	224	363	37.0
23	235	380	38.7
24	245	396	40.4
25	255	413	42.1
26	265	429	43.8
27	275	446	45.5
28	286	462	47.2
29	296	479	48.8
30	306	495	50.5
31	316	512	52.2
32	326	528	53.9
33	337	545	55.6
34	347	561	57.3
35	357	578	58.9
36	367	594	60.6
37	377	611	62.3
38	388	627	64.0
39	398	644	65.7
40	408	660	67.4

圧力		荷重	
MPa	kg/cm ²	kN	ton
41	418	677	69.0
42	428	693	70.7
43	439	710	72.4
44	449	726	74.1
45	459	743	75.8
46	469	759	77.5
47	479	776	79.1
48	490	792	80.8
49	500	809	82.5
50	510	826	84.2
51	520	842	85.9
52	530	859	87.6
53	541	875	89.3
54	551	892	90.9
55	561	908	92.6
56	571	925	94.3
57	581	941	96.0
58	592	958	97.7
59	602	974	99.4
60	612	991	101.0
60.6	618	1001	102.1