

圧力荷重換算表

2000kN125ストローク安全ナット付き 油圧ジャッキ ユニバーサル付き

最低機械高	525 mm
受圧面積	314.2 cm ²
最高使用圧力	63.7 MPa
所要油量	3.9 L
重量	約250 kg

圧力 : MPa $\times 10.2$ \rightarrow kg/cm²
 荷重 : ton $\times 9.8$ \rightarrow kN
 圧力[MPa] × 受圧面積[cm²] / 10 = 荷重[kN]

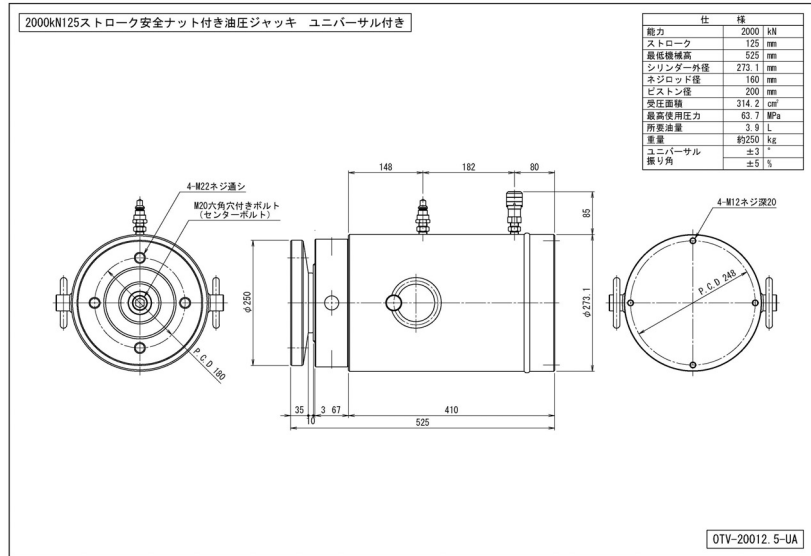

圧力		荷重	
MPa	kg/cm ²	kN	ton
1	10	31	3.2
2	20	63	6.4
3	31	94	9.6
4	41	126	12.8
5	51	157	16.0
6	61	189	19.2
7	71	220	22.4
8	82	251	25.6
9	92	283	28.8
10	102	314	32.0
11	112	346	35.3
12	122	377	38.5
13	133	408	41.7
14	143	440	44.9
15	153	471	48.1
16	163	503	51.3
17	173	534	54.5
18	184	566	57.7
19	194	597	60.9
20	204	628	64.1

圧力		荷重	
MPa	kg/cm ²	kN	ton
21	214	660	67.3
22	224	691	70.5
23	235	723	73.7
24	245	754	76.9
25	255	786	80.1
26	265	817	83.3
27	275	848	86.5
28	286	880	89.7
29	296	911	92.9
30	306	943	96.1
31	316	974	99.4
32	326	1005	102.6
33	337	1037	105.8
34	347	1068	109.0
35	357	1100	112.2
36	367	1131	115.4
37	377	1163	118.6
38	388	1194	121.8
39	398	1225	125.0
40	408	1257	128.2

圧力		荷重	
MPa	kg/cm ²	kN	ton
41	418	1288	131.4
42	428	1320	134.6
43	439	1351	137.8
44	449	1382	141.0
45	459	1414	144.2
46	469	1445	147.4
47	479	1477	150.6
48	490	1508	153.8
49	500	1540	157.0
50	510	1571	160.2
51	520	1602	163.4
52	530	1634	166.7
53	541	1665	169.9
54	551	1697	173.1
55	561	1728	176.3
56	571	1760	179.5
57	581	1791	182.7
58	592	1822	185.9
59	602	1854	189.1
60	612	1885	192.3
61	622	1917	195.5
62	632	1948	198.7
63	643	1979	201.9
63.7	650	2001	204.1