

圧力荷重換算表

3000kN220ストローク油圧ジャッキ ユニバーサルヘッド付き H=485mm

最低機械高	485 mm
受圧面積	490.9 cm ²
最高使用圧力	61.1 MPa
所要油量	10.8 L
重量	約230 kg

圧力 : MPa $\times 10.2$ \rightarrow kg/cm²
 荷重 : ton $\times 9.8$ \rightarrow kN
 圧力[MPa] × 受圧面積[cm²]/10=荷重[kN]

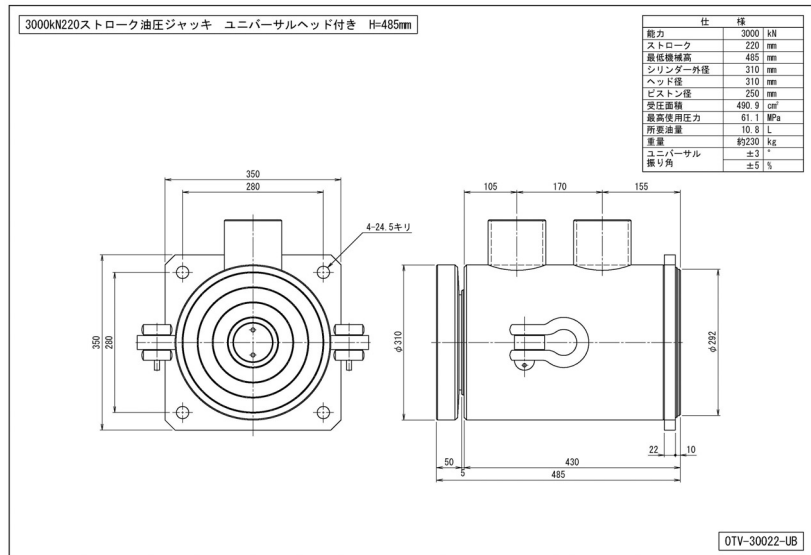

圧力		荷重	
MPa	kg/cm ²	kN	ton
1	10	49	5.0
2	20	98	10.0
3	31	147	15.0
4	41	196	20.0
5	51	245	25.0
6	61	295	30.0
7	71	344	35.1
8	82	393	40.1
9	92	442	45.1
10	102	491	50.1
11	112	540	55.1
12	122	589	60.1
13	133	638	65.1
14	143	687	70.1
15	153	736	75.1
16	163	785	80.1
17	173	835	85.1
18	184	884	90.1
19	194	933	95.1
20	204	982	100.1

圧力		荷重	
MPa	kg/cm ²	kN	ton
21	214	1031	105.2
22	224	1080	110.2
23	235	1129	115.2
24	245	1178	120.2
25	255	1227	125.2
26	265	1276	130.2
27	275	1325	135.2
28	286	1375	140.2
29	296	1424	145.2
30	306	1473	150.2
31	316	1522	155.2
32	326	1571	160.2
33	337	1620	165.2
34	347	1669	170.2
35	357	1718	175.3
36	367	1767	180.3
37	377	1816	185.3
38	388	1865	190.3
39	398	1915	195.3
40	408	1964	200.3

圧力		荷重	
MPa	kg/cm ²	kN	ton
41	418	2013	205.3
42	428	2062	210.3
43	439	2111	215.3
44	449	2160	220.3
45	459	2209	225.3
46	469	2258	230.3
47	479	2307	235.3
48	490	2356	240.3
49	500	2405	245.4
50	510	2455	250.4
51	520	2504	255.4
52	530	2553	260.4
53	541	2602	265.4
54	551	2651	270.4
55	561	2700	275.4
56	571	2749	280.4
57	581	2798	285.4
58	592	2847	290.4
59	602	2896	295.4
60	612	2945	300.4
61	622	2994	305.4
61.1	623	2999	305.9