

圧力荷重換算表

1000kN200ストロークCH型 油圧ジャッキ

最低機械高	385 mm
ホール径	64 mm
受圧面積	150.2 cm ²
最高使用圧力	66.6 MPa
所要油量	3.0 L
重量	約75 kg

圧力 : MPa $\times 10.2$ kg/cm²
 荷重 : ton $\times 9.8$ kN
 圧力[MPa] \times 受圧面積[cm²]/10=荷重[kN]

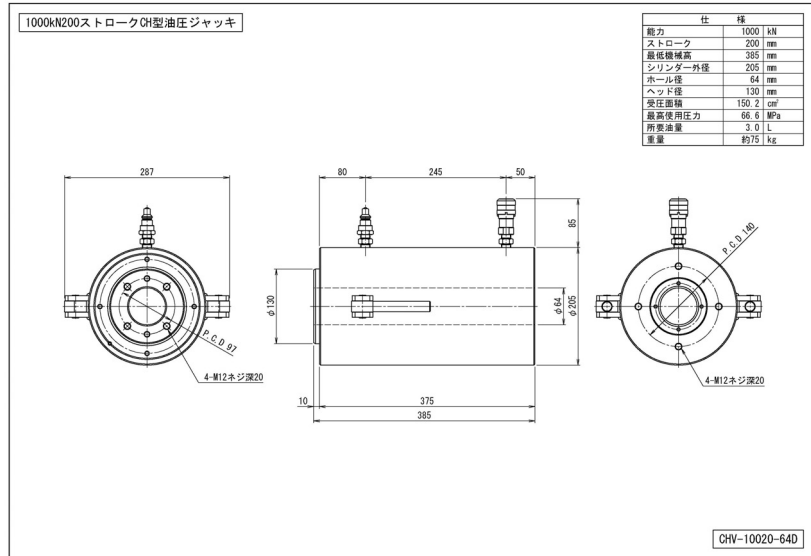

圧力		荷重	
MPa	kg/cm ²	kN	ton
1	10	15	1.5
2	20	30	3.1
3	31	45	4.6
4	41	60	6.1
5	51	75	7.7
6	61	90	9.2
7	71	105	10.7
8	82	120	12.3
9	92	135	13.8
10	102	150	15.3
11	112	165	16.9
12	122	180	18.4
13	133	195	19.9
14	143	210	21.4
15	153	225	23.0
16	163	240	24.5
17	173	255	26.0
18	184	270	27.6
19	194	285	29.1
20	204	300	30.6

圧力		荷重	
MPa	kg/cm ²	kN	ton
21	214	315	32.2
22	224	330	33.7
23	235	345	35.2
24	245	360	36.8
25	255	376	38.3
26	265	391	39.8
27	275	406	41.4
28	286	421	42.9
29	296	436	44.4
30	306	451	46.0
31	316	466	47.5
32	326	481	49.0
33	337	496	50.6
34	347	511	52.1
35	357	526	53.6
36	367	541	55.2
37	377	556	56.7
38	388	571	58.2
39	398	586	59.7
40	408	601	61.3

圧力		荷重	
MPa	kg/cm ²	kN	ton
41	418	616	62.8
42	428	631	64.3
43	439	646	65.9
44	449	661	67.4
45	459	676	68.9
46	469	691	70.5
47	479	706	72.0
48	490	721	73.5
49	500	736	75.1
50	510	751	76.6
51	520	766	78.1
52	530	781	79.7
53	541	796	81.2
54	551	811	82.7
55	561	826	84.3
56	571	841	85.8
57	581	856	87.3
58	592	871	88.9
59	602	886	90.4
60	612	901	91.9
61	622	916	93.5
62	632	931	95.0
63	643	946	96.5
64	653	961	98.1
65	663	976	99.6
66	673	991	101.1
66.6	679	1000	102.0