

10連式油圧同調装置操作盤

仕様	
重量	約220 kg

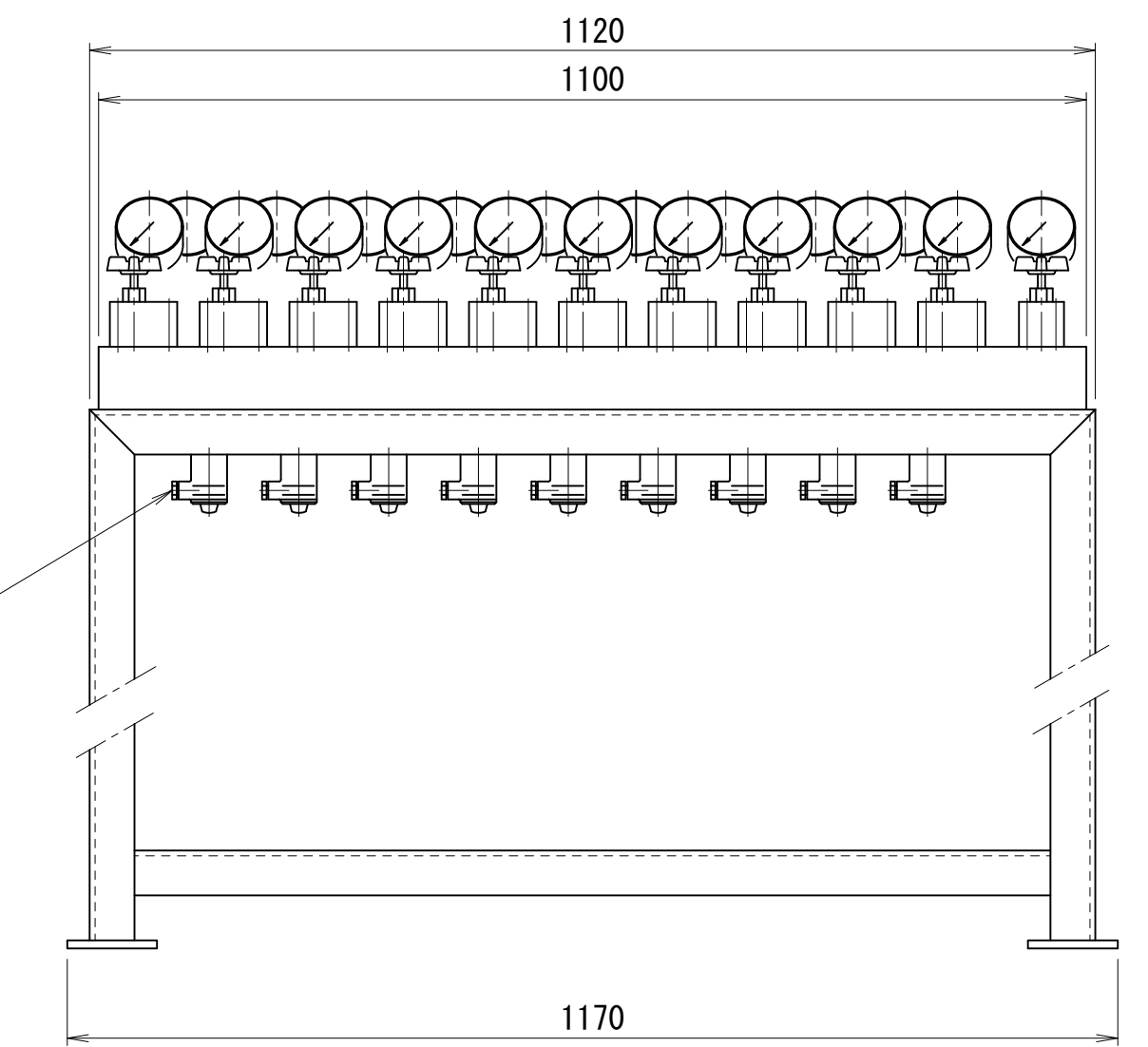

回路図

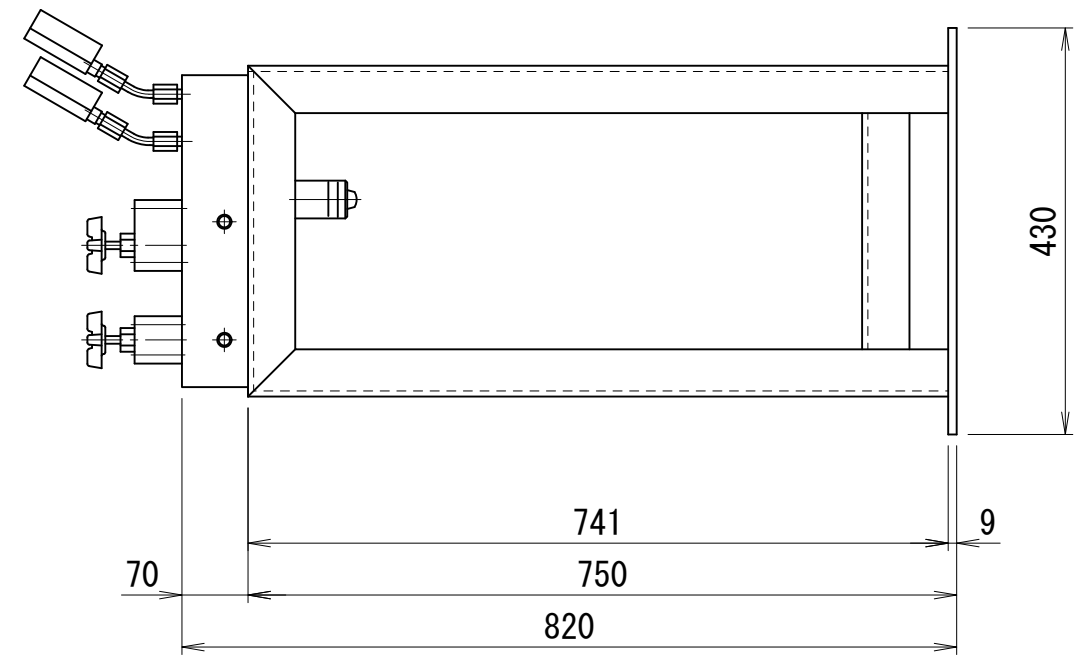
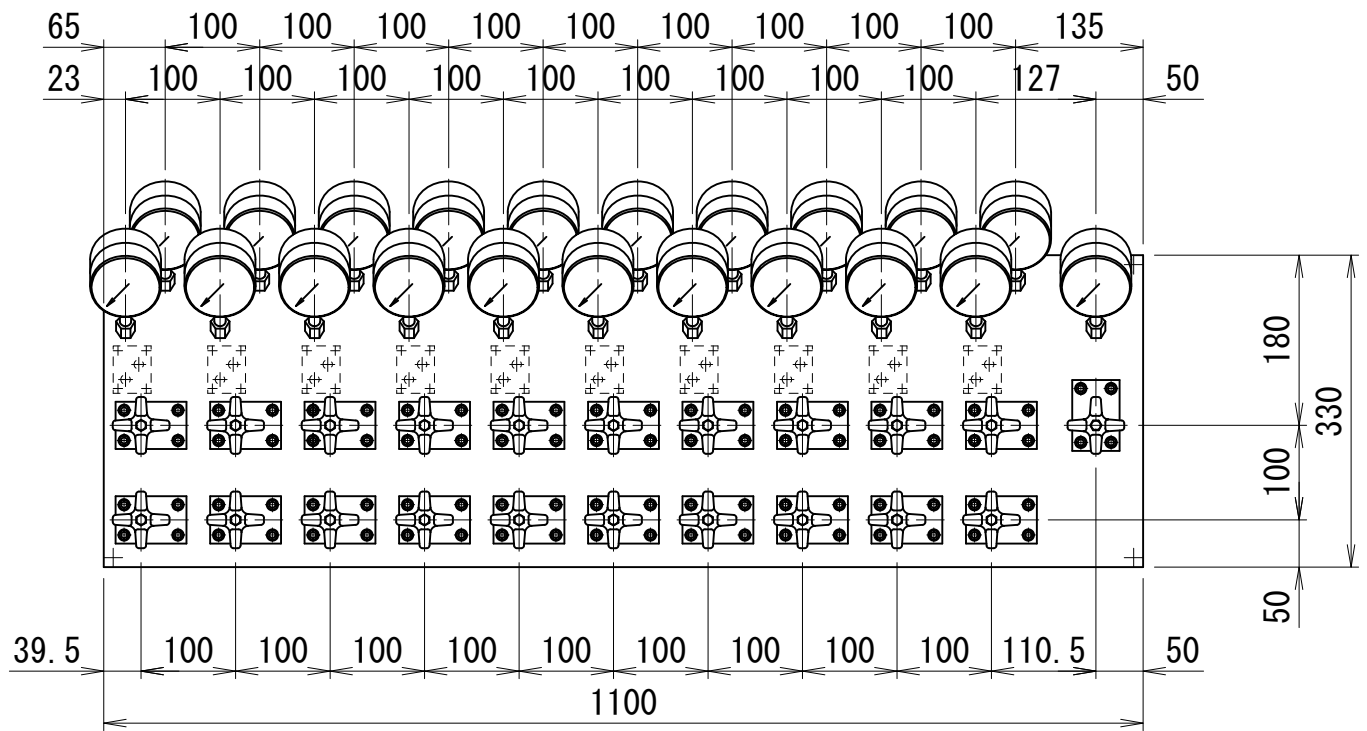